

Thank you for purchasing the UltraDry Budget from the DrySenz hand dryer range. This fashionable, high quality hand dryer is ideal for any public washroom that experiences light to heavy usage. The product comes complete with a 5 year manufacturer's guarantee on all internal parts for your peace of mind. Please keep your receipt and contact the wholesaler that you purchased it from in case of any fault occurring.

DIRECTION FOR INSTALLING

- Ensure that the connecting power sources are off before beginning installation.
- A switch with two poles should be applied between this appliance and the power supply cable, the terminal gauge should be large than >3mm.
- The appliance should be earthed / grounded
- The appliance should be fitted by a qualified electrician

This appliance should be grounded

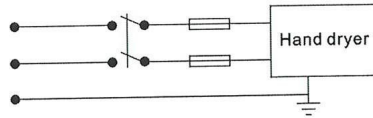

1. Remove the cover as per diagram 5. Do not force, ensure that all bolts are removed and wires are disconnected.
2. Mark to fixing point as per diagram 2. This should be to the measurements shown in drawing 2. Then drill holes of $\varnothing 8\text{mm}$, and 35mm deep.
3. Fix the base to the holes, first inserting the plastic fixings and then screws provided as per diagram 3.
4. Fix the hand dryer as per drawing 4, {1} Connect the earthed/grounded wire to the cover, {2} Connect the cover sensor lead wire to the base. {3} Hang the cover on the base, {4} Fit the base and the cover firmly together, and screw down two screws. {5} Switch on the power, place hands under the sensor to check it is operating correctly.
5. To make the installation safe, cut the power off, lead the wire into the hand dryer through the base hole, and connect the wire to the N and L clamps.

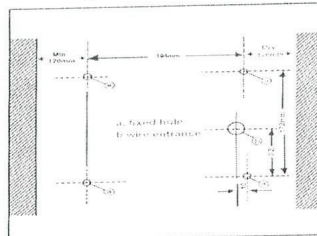

Drawing 2

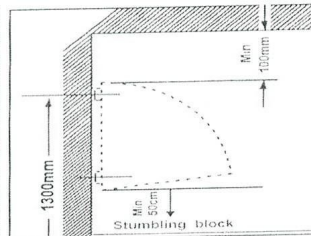

Drawing 3

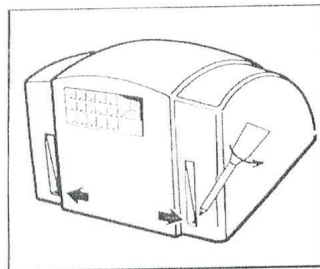

Drawing 4

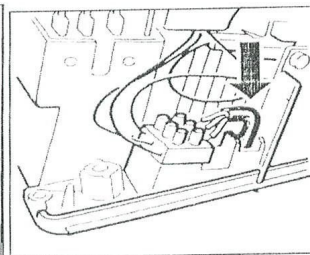

Drawing 5

1. When installation is complete, switch on the power and the appliance will work automatically.
2. Hands need to be positioned between 0-11 cm from the sensor to activate and the dryer will stop 1 second after removing hands. It has an auto cut out of 1 minute.

We have given consideration to different installation conditions, so the sensor can be adjusted.

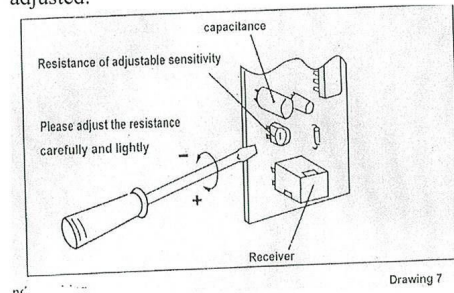

Note:

1. This appliance must be installed out of reach of water supplies including was basins, baths, showers, swimming pools.
2. It should be installed by a qualified electrician.
3. A qualified electrician should be called if the power cables become damaged.
4. Avoid direct water injection to the appliance
5. Do not cover the air inlet or outlet.
6. In the event of a malfunction please switch off and contact your supplier.
7. Maintenance and repairing

SPECIFICATION:

Voltage:	220v
Frequency:	50Hz
Rated Power:	2500w
Consumption:	11.4a
Waterproof:	IPX1

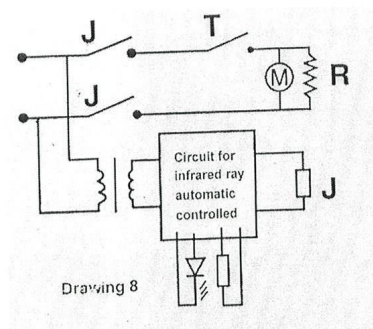

ACCESSORIES

- 1 x copy of user manual
- 1 x installation guide
- 1 x pack of 4 pieces screws, 1 wrench and 4 x $\phi 8$ mm plastic screw fixings.